

SUMTOR

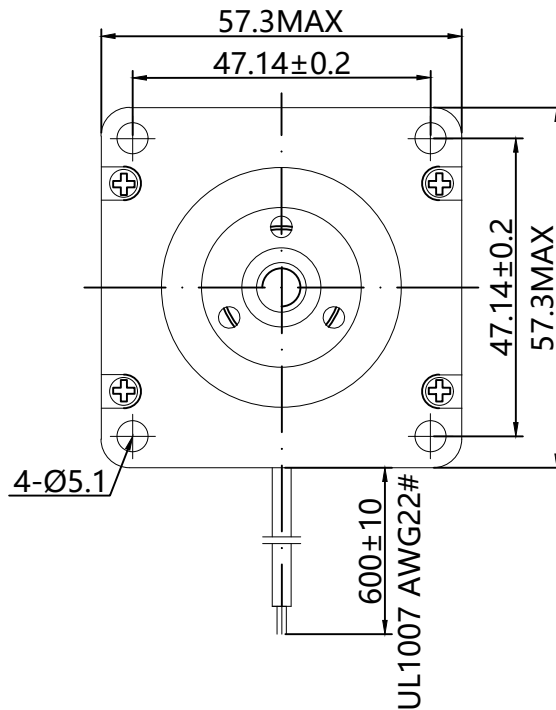

绕组接线图

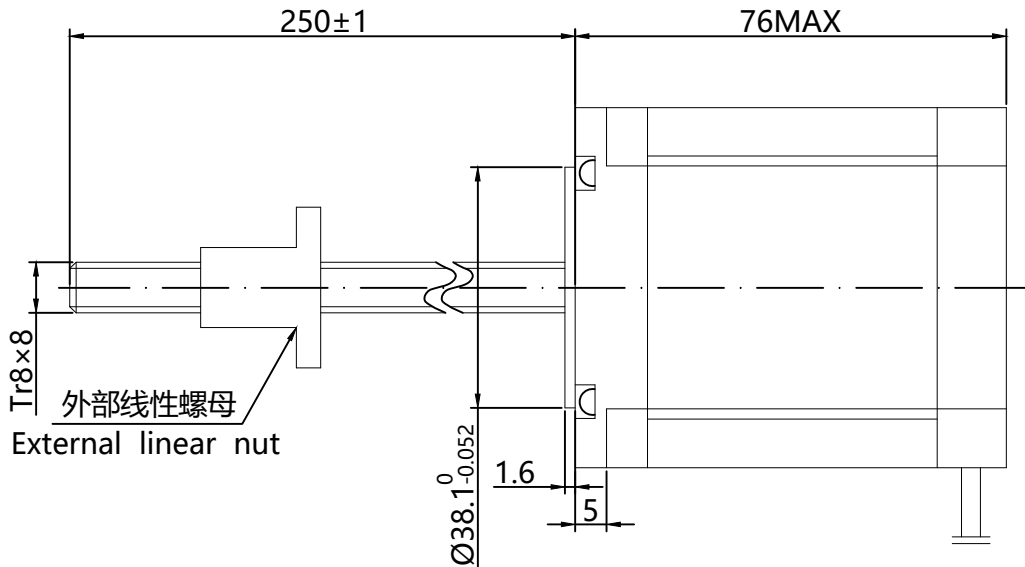
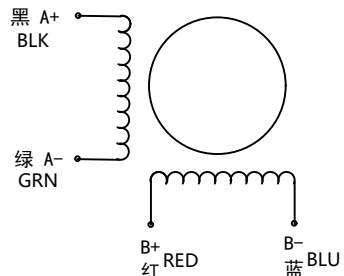

MR003-A 白色POM (White POM)

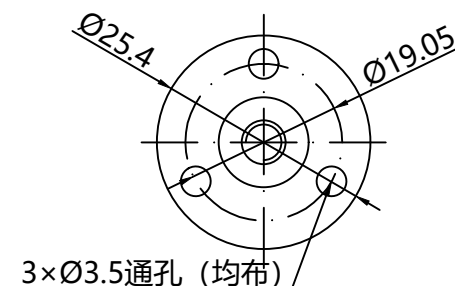
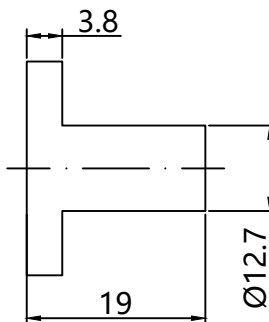

外形尺寸: unit=mm

Electrical Specifications			COMMENT	螺杆规格 The screw shaft specifications	
STEP ANGLE	步距角	1.8 ° /STEP			规格Modle
RATED VOLTAGE	相电压	3.0 V		步长Resolution	0.04mm
CURRENT	相电流	3.0 A/PHASE		导程Lead	8
RESISTANCE	相电阻	1.0 Ω/PHASE		螺距Screw head	2
INDUCTANCE	相电感	3.5 mH/PHASE		型号Nut NO:	WHC
HOLDING TORQUE	静力矩	190 N. cm			
DETENT TORQUE	定位力矩	700 g. cm			
ROTOR INERTIA	转动惯量	460 g. cm ²			
MOTOR WEIGHT	重量	1090 g			

序号	数量	名称/代号/材料			
设计	审核	批准	日期	图号	比例
邹志仁					1:1
无锡三拓电气设备有限公司 SUMTOR(Wuxi) Electric CO.,Ltd			57HZ7630T8C8-250		
项目			版本	V1.0	